

G - EVO SERIES

G-EVO 605 R

POT & UTENSIL WASHER - FRONT LOADING EXECUTION

DESCRIPTION

Heavy Duty pot & utensil washer - three phase - double skin execution - upper control panel - Wi-Fi connectivity and Comenda web portal for remote control and monitoring as a standard - integrated RCD Rinse Control Device.

STANDARD FEATURES

DURABILITY

- Double skin insulated body in AISI 304;
- Molded double skin counterbalanced insulated door;
- Ergonomic stainless steel handle.

HYGIENE

- Stainless steel extractable filters;
- RCD - Rinse control device;
- Stainless steel separated Wash and rinse arms;
- One piece deep drawn wash tank with rounded corners to prevent soil deposit;
- Removable wash and rinse arms support;
- Self-cleaning cycle at unit switch off;
- Double filtration system: stainless steel surface filter and basket filter.

SAFETY

- Magnetic microswitch to stop the cycle in case of accidental door opening;
- Adjustable Thermostop as a standard: it ensures that the correct operating temperatures are reached;
- Temperature measurement via electronic probes: accuracy and reliability;
- Provision for peak power reduction connection (PCE).

POWER AT YOUR FINGERTIPS

- Upper control panel;
- Display with temperature indicators;
- 4 programming options for washing cycles (short - medium - long - intensive);
- Diagnostics with alphanumeric alarm codes;
- Cycle progress with graphics countdown;
- Cycles and performances counter: allows the technician to plan maintenance. Useful for statistics and usage informations;
- Colour- coded status indicators: the intuitive START button features clear cycle monitoring with to help your operations to run at its best.

G-EVO 605 R

STANDARD FEATURES

WI-FI CONNECTIVITY AND REMOTE MONITORING

The new Wi-Fi Pack, allows the operator to easy monitoring the machine functions and access a vast amount of information; prevent possible failures by managing the anomalies in real time from smartphome, tablet and PC and keep consumptions under control.

COMENDA CLOUD WASHING WEB PORTAL

Simple and intuitive gives you the power to:

- Check the main operating parameters of the unit;
- Start/stop the washing cycle;
- Download Records and HACCP reports;
- Access the alarm list and manage the anomalies;
- Check and download technical documentation;
- Save unit specific parameters or data settings;
- Adjust temperatures and dosage for chemicals;
- Plan the calls out for fixing only if necessary;
- Develop periodic reports for the end user;
- Make a remote assessment of wear parts;

STANDARD EQUIPMENT

RACKS & INSERTS

- 1 stainless steel 650x700 mm rack
- 1 insert for 3 bake pans

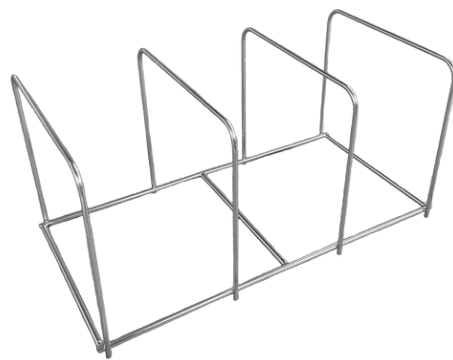
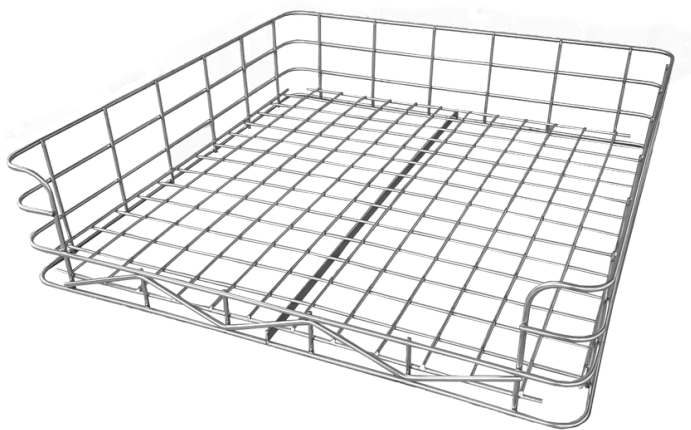

















G-EVO 605 R

OPTIONAL

- Surcharge for built-in drain pump;
- Surcharge for built-in peristaltic detergent dosing pump;
- Surcharge for built-in peristaltic rinse aid dosing pump;
- Drain Pump kit (provided separately);
- Detergent dosing pump kit (provided separately);
- Rinse Aid dosing pump kit (provided separately);
- Surcharge for 9/14 kW booster;
- CRC - Heat Recovery Unit: allows for cold water connection (15 to 30 deg C); allows for consistent energy savings, minimizing the steam released;
- WP2- Heat Pump: this device helps to reduce steam, creating a healthier working environment. It absorbs the heat produced by the machine reducing latent heat and cooling the air that is released into the premises;
- External Water Softener;
- Special Voltages on request;
- Steam heated execution;
- "H" Execution - Extra Large 800 mm clearance;
- Folding Door

G-EVO 605 R

TECHNICAL DATA

	EXTERNAL SIZE	861x900x1915/2065* mm
	OVERALL SIZE	1240x2190/2340* mm
	CLEARANCE	650/800* mm
	RACK SIZE	650x700 mm
	ELECTRICAL SUPPLY	400V/3N/50Hz
	WASH PROGRAM LENGHT	120/240/360/480 "
	MAX OUTPUT - WARM WATER CONNECTION (55 C°) ●	30/15/10/8 racks/h
	MAX OUTPUT - COLD WATER CONNECTION (15 C°) ●	16/15/10/8 racks/h
	RINSE WATER CONSUMPTION	4 l/rack
	TANK HEATER ELEMENT	6 kW
	BOOSTER HEATER ELEMENT	6 kW
	TANK SIZE	60 l
	WASH PUMP	3 kW
	INSTALLED LOAD	9 kW
	NOISE	68 dB(A)
	WEIGHT	200 kg

*"H" Execution - Extra Large 800 mm clearance

CRC Execution: machine height will increase by 300 mm

WP Execution: machine height will increase by 590 mm

G-EVO 605 R

TECHNICAL DRAWINGS

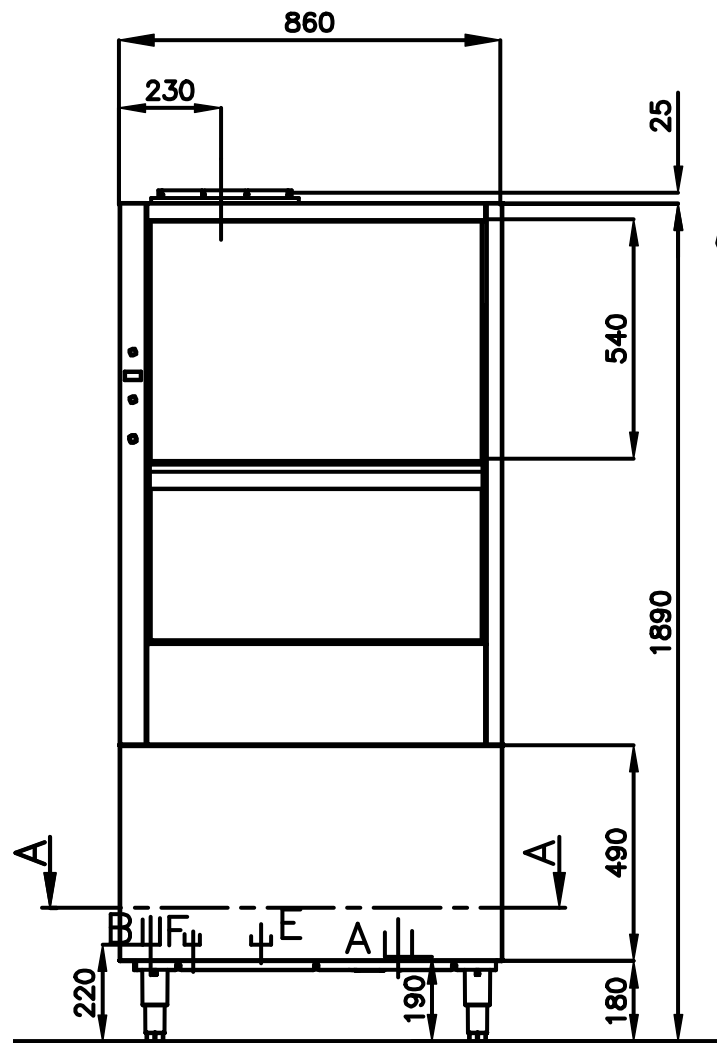
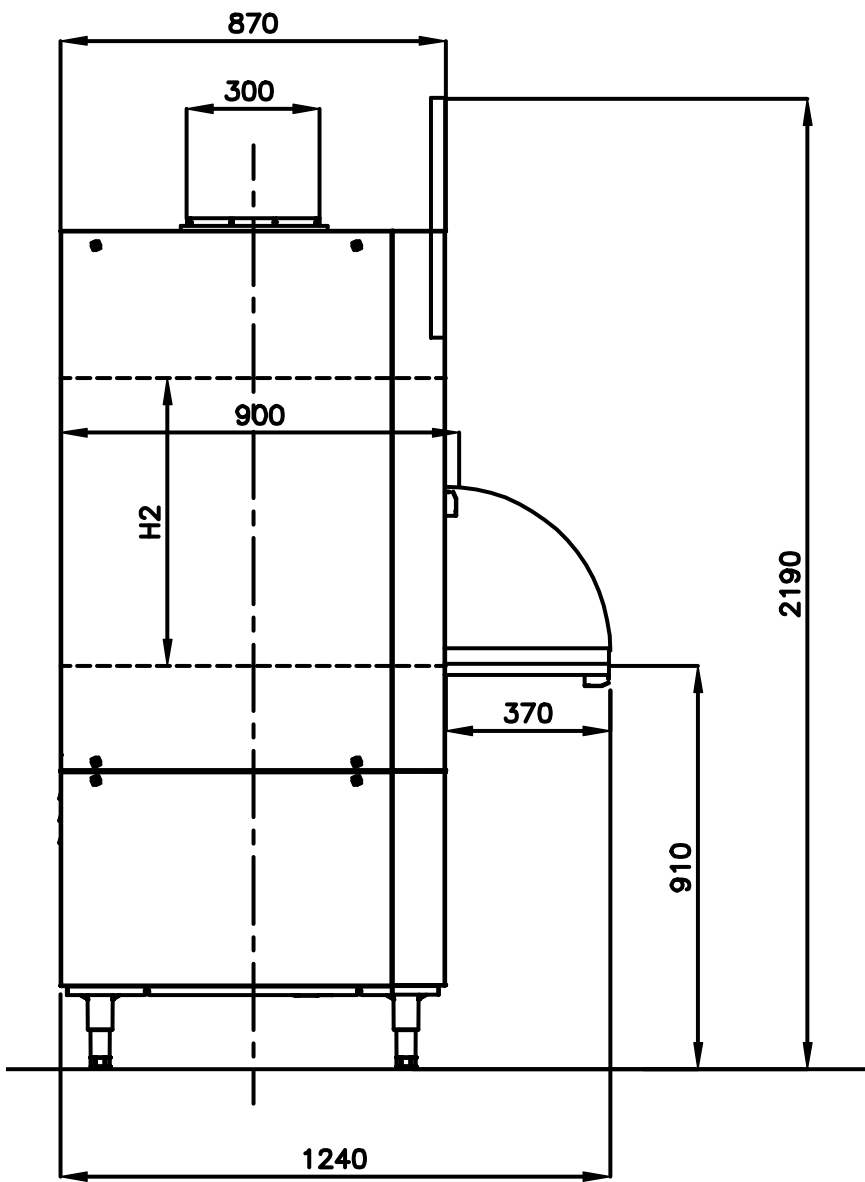

LATO ANTERIORE MACCHINA
FRONT OF MACHINE
LADO ANTERIOR MAQUINA
COTE ANTERIEUR MACHINE
VORDERSEITE

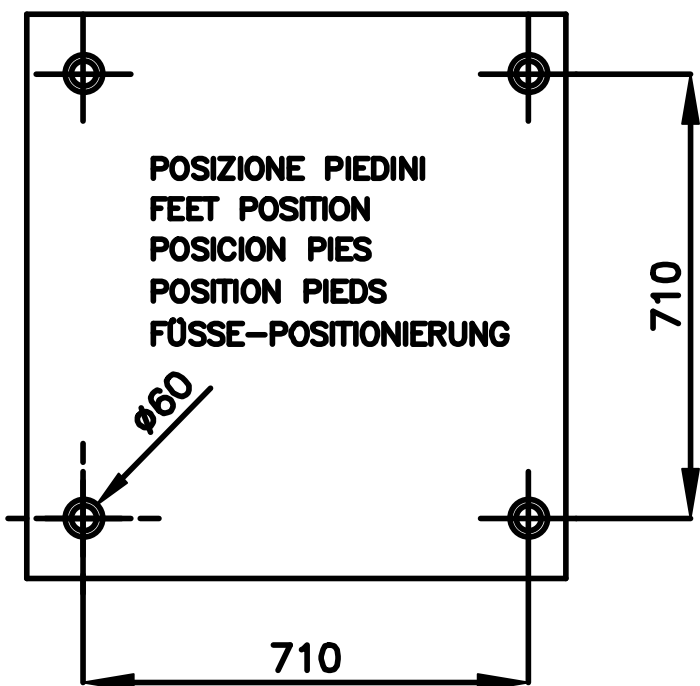

POSIZIONE PIEDINI
FEET POSITION
POSICION PIES
POSITION PIEDS
FÜSSE-POSITIONIERUNG

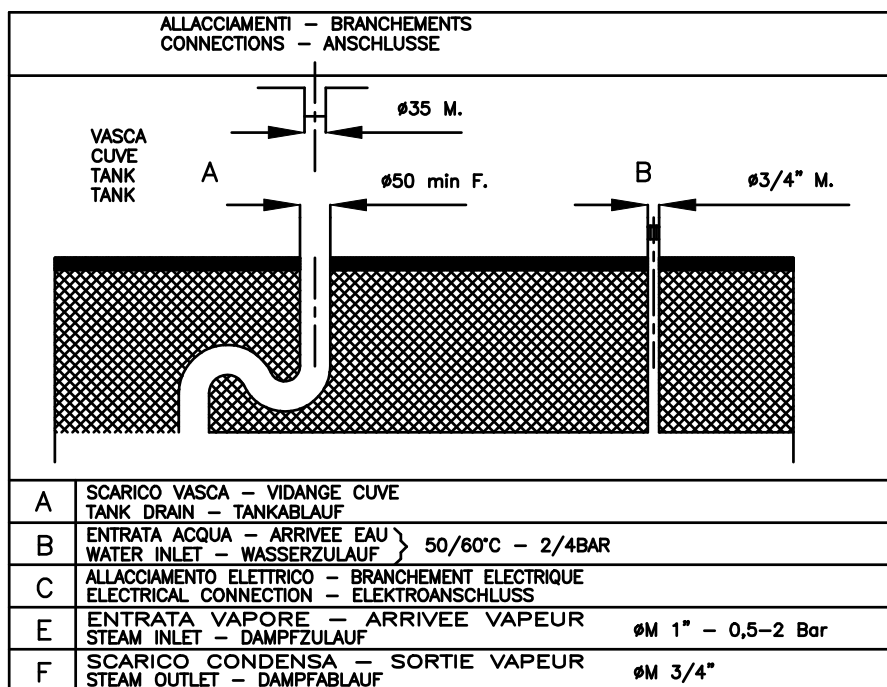

The stated values may deviate depending on installation conditions and items washed.
Comenda Ali Group srl reserves the right to modify product specifications at any time without prior notice.